

DATA SHEET

BFR93AW

NPN 5 GHz wideband transistor

Product specification
Supersedes data of November 1992
File under Discrete Semiconductors, SC14

1995 Sep 18

NPN 5 GHz wideband transistor

BFR93AW

FEATURES

- High power gain
- Gold metallization ensures excellent reliability
- SOT323 (S-mini) package.

APPLICATIONS

It is designed for use in RF amplifiers, mixers and oscillators with signal frequencies up to 1 GHz.

DESCRIPTION

Silicon NPN transistor encapsulated in a plastic SOT323 (S-mini) package. The BFR93AW uses the same crystal as the SOT23 version, BFR93A.

PINNING

PIN	DESCRIPTION
1	base
2	emitter
3	collector

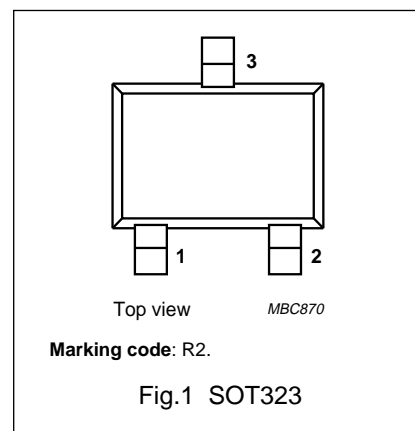

QUICK REFERENCE DATA

SYMBOL	PARAMETER	CONDITIONS	MIN.	TYP.	MAX.	UNIT
V_{CBO}	collector-base voltage	open emitter	–	–	15	V
V_{CEO}	collector-emitter voltage	open base	–	–	12	V
I_C	collector current (DC)		–	–	35	mA
P_{tot}	total power dissipation	up to $T_s = 93\text{ °C}$; note 1	–	–	300	mW
h_{FE}	DC current gain	$I_C = 30\text{ mA}$; $V_{CE} = 5\text{ V}$	40	90	–	
C_{re}	feedback capacitance	$I_C = 0$; $V_{CE} = 5\text{ V}$; $f = 1\text{ MHz}$; $T_{amb} = 25\text{ °C}$	–	0.6	–	pF
f_T	transition frequency	$I_C = 30\text{ mA}$; $V_{CE} = 5\text{ V}$; $f = 500\text{ MHz}$	4	5	–	GHz
G_{UM}	maximum unilateral power gain	$I_C = 30\text{ mA}$; $V_{CE} = 8\text{ V}$; $f = 1\text{ GHz}$; $T_{amb} = 25\text{ °C}$	–	13	–	dB
		$I_C = 30\text{ mA}$; $V_{CE} = 8\text{ V}$; $f = 2\text{ GHz}$; $T_{amb} = 25\text{ °C}$	–	8	–	dB
F	noise figure	$I_C = 5\text{ mA}$; $V_{CE} = 8\text{ V}$; $f = 1\text{ GHz}$; $\Gamma_s = \Gamma_{opt}$	–	1.5	–	dB
T_j	junction temperature		–	–	150	°C

Note

1. T_s is the temperature at the soldering point of the collector pin.

NPN 5 GHz wideband transistor

BFR93AW

LIMITING VALUES

In accordance with the Absolute Maximum Rating System (IEC 134).

SYMBOL	PARAMETER	CONDITION	MIN.	MAX.	UNIT
V _{CBO}	collector-base voltage	open emitter	–	15	V
V _{CEO}	collector-emitter voltage	open base	–	12	V
V _{EBO}	emitter-base voltage	open collector	–	2	V
I _C	collector current (DC)		–	35	mA
P _{tot}	total power dissipation	up to T _s = 93 °C; see Fig.2; note 1	–	300	mW
T _{stg}	storage temperature		–65	+150	°C
T _j	junction temperature		–	150	°C

THERMAL CHARACTERISTICS

SYMBOL	PARAMETER	CONDITION	VALUE	UNIT
R _{th j-s}	thermal resistance from junction to soldering point	up to T _s = 93 °C; note 1	190	K/W

Note to the Limiting values and Thermal characteristics

1. T_s is the temperature at the soldering point of the collector pin.

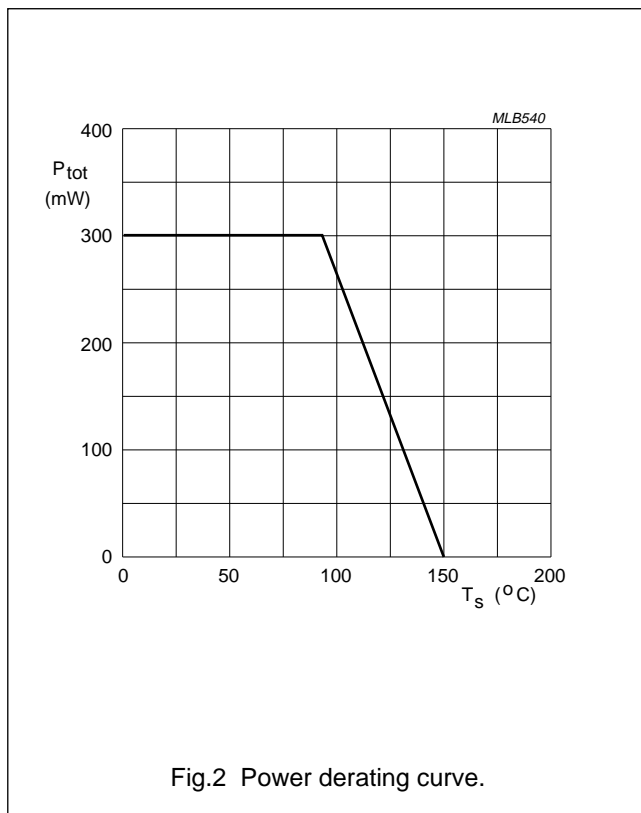

NPN 5 GHz wideband transistor

BFR93AW

CHARACTERISTICS

$T_j = 25\text{ °C}$ (unless otherwise specified).

SYMBOL	PARAMETER	CONDITIONS	MIN.	TYP.	MAX.	UNIT
I_{CBO}	collector leakage current	$I_E = 0; V_{CB} = 5\text{ V}$	–	–	50	nA
h_{FE}	DC current gain	$I_C = 30\text{ mA}; V_{CE} = 5\text{ V}$	40	90	–	
C_c	collector capacitance	$I_E = i_e = 0; V_{CB} = 5\text{ V}; f = 1\text{ MHz}$	–	0.7	–	pF
C_e	emitter capacitance	$I_C = i_c = 0; V_{EB} = 0.5\text{ V}; f = 1\text{ MHz}$	–	2.3	–	pF
C_{re}	feedback capacitance	$I_C = 0; V_{CE} = 5\text{ V}; f = 1\text{ MHz}$	–	0.6	–	pF
f_T	transition frequency	$I_C = 30\text{ mA}; V_{CE} = 5\text{ V}; f = 500\text{ MHz}$	4	5	–	GHz
G_{UM}	maximum unilateral power gain; note 1	$I_C = 30\text{ mA}; V_{CE} = 8\text{ V}; f = 1\text{ GHz}; T_{amb} = 25\text{ °C}$	–	13	–	dB
		$I_C = 30\text{ mA}; V_{CE} = 8\text{ V}; f = 2\text{ GHz}; T_{amb} = 25\text{ °C}$	–	8	–	dB
F	noise figure	$I_C = 5\text{ mA}; V_{CE} = 8\text{ V}; f = 1\text{ GHz}; \Gamma_s = \Gamma_{opt}$	–	1.5	–	dB
		$I_C = 5\text{ mA}; V_{CE} = 8\text{ V}; f = 2\text{ GHz}; \Gamma_s = \Gamma_{opt}$	–	2.1	–	dB

Note

1. G_{UM} is the maximum unilateral power gain, assuming s_{12} is zero and $G_{UM} = 10 \log \frac{|s_{21}|^2}{(1 - |s_{11}|^2)(1 - |s_{22}|^2)}$ dB.

NPN 5 GHz wideband transistor

BFR93AW

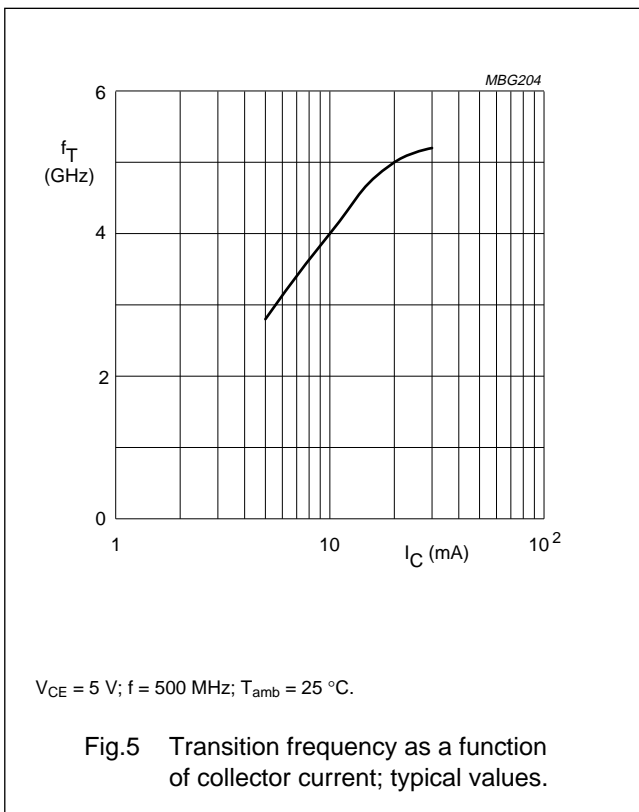
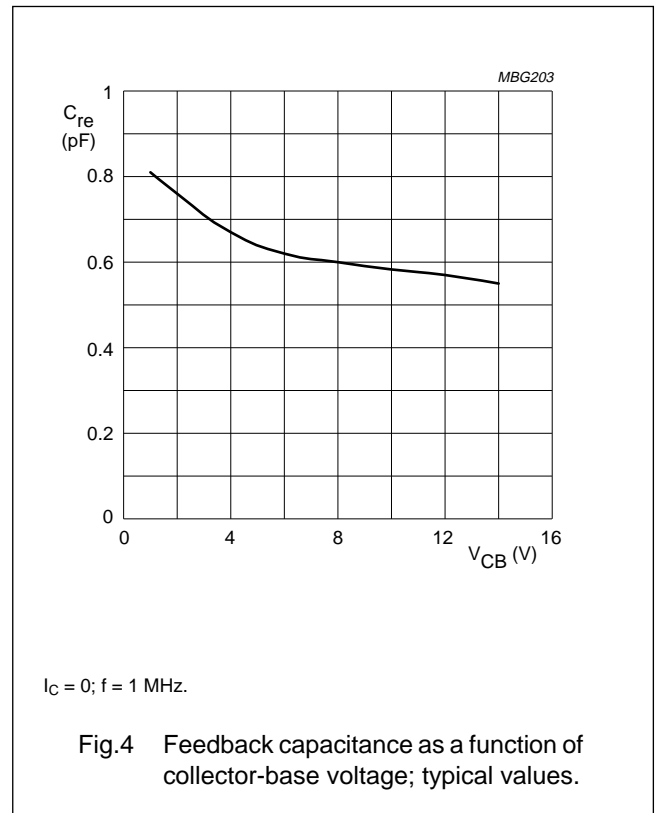
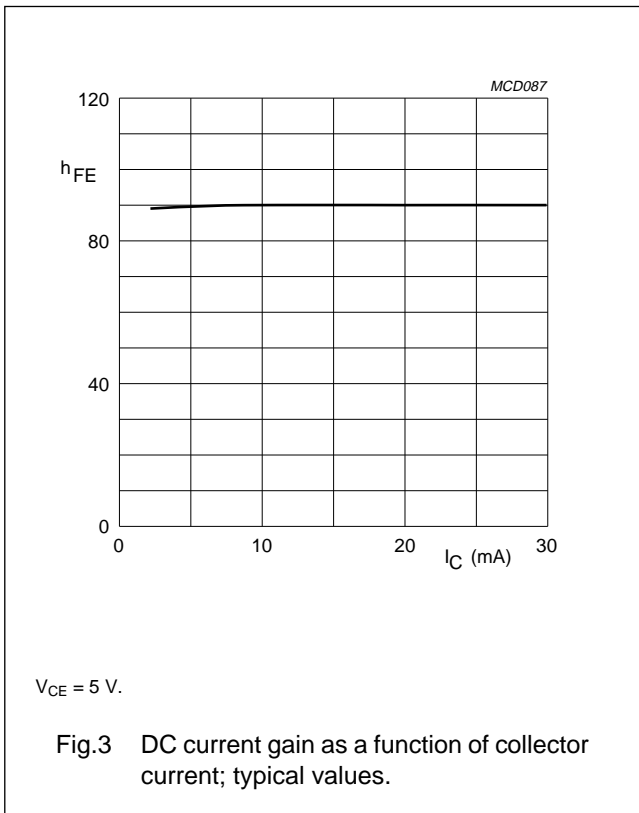

NPN 5 GHz wideband transistor

BFR93AW

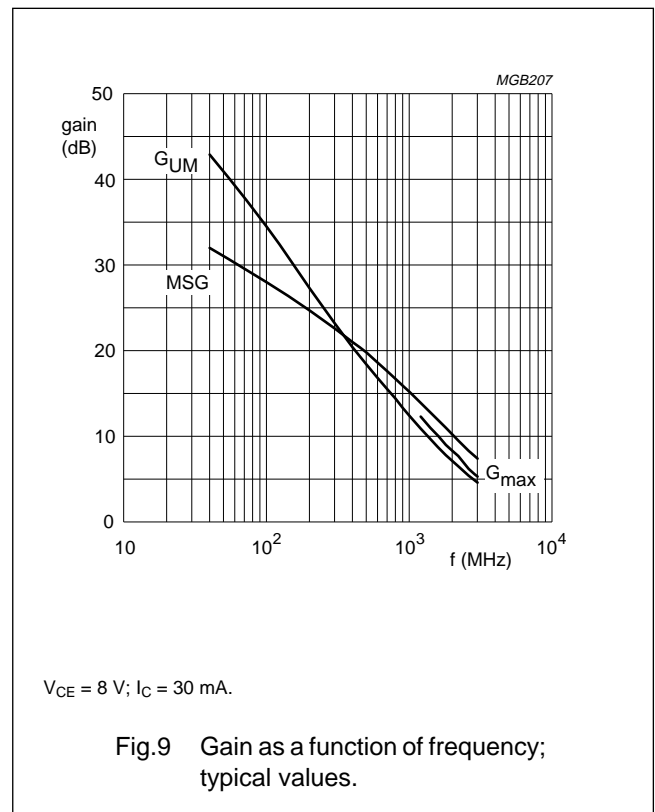
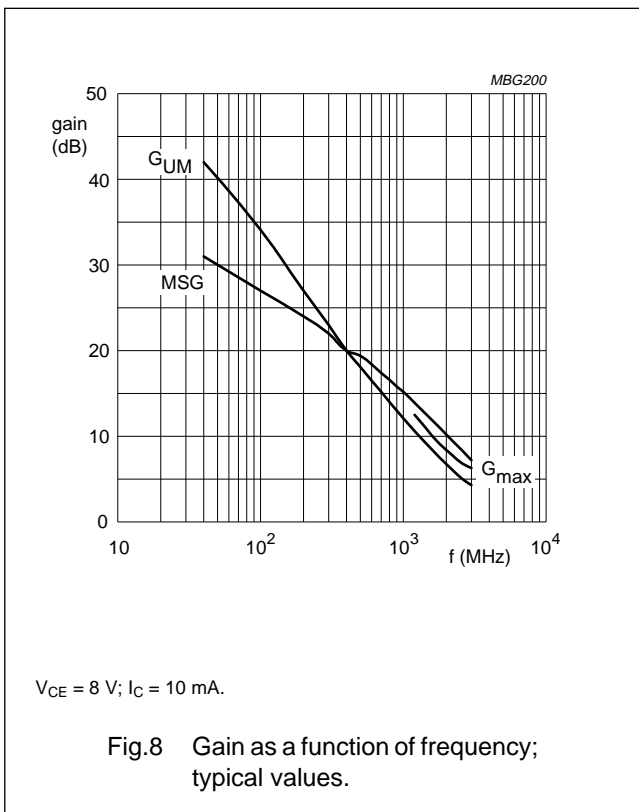
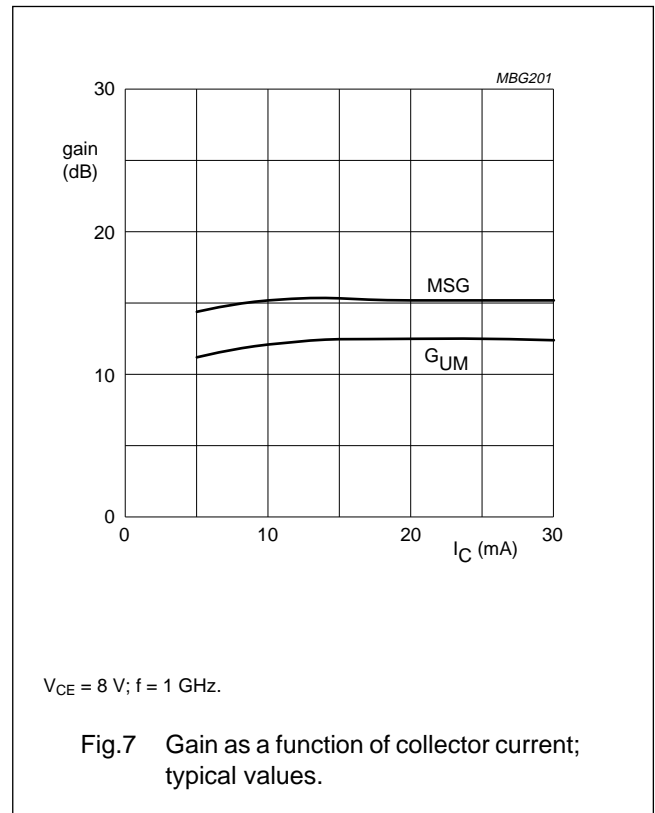
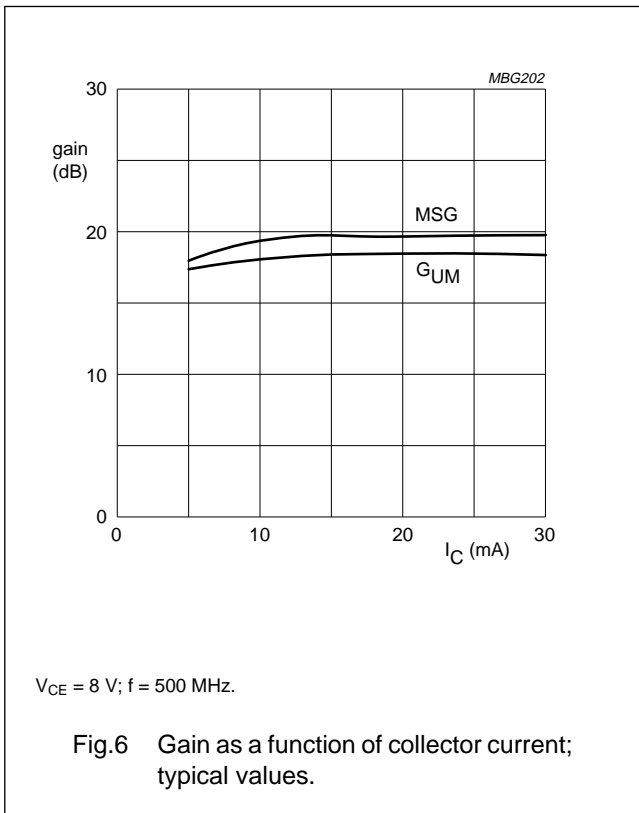

NPN 5 GHz wideband transistor

BFR93AW

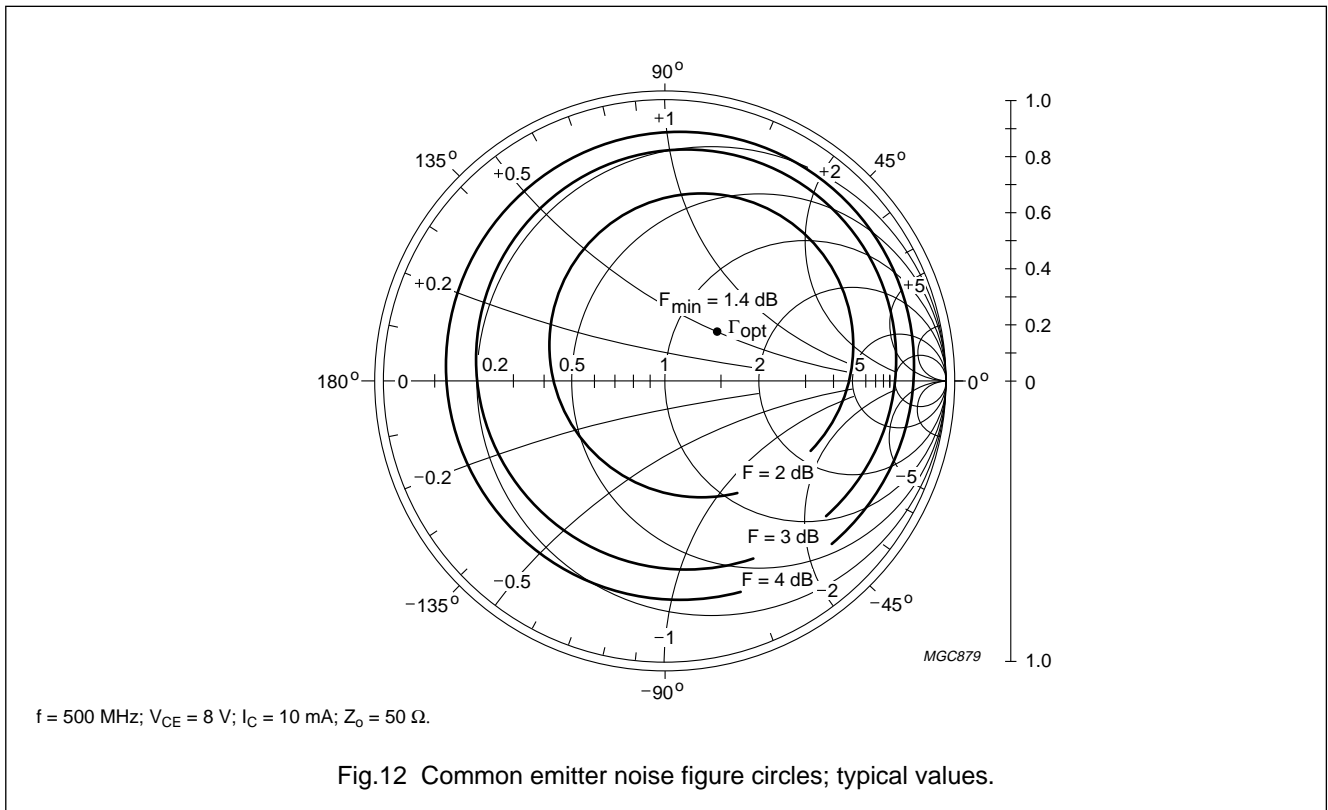
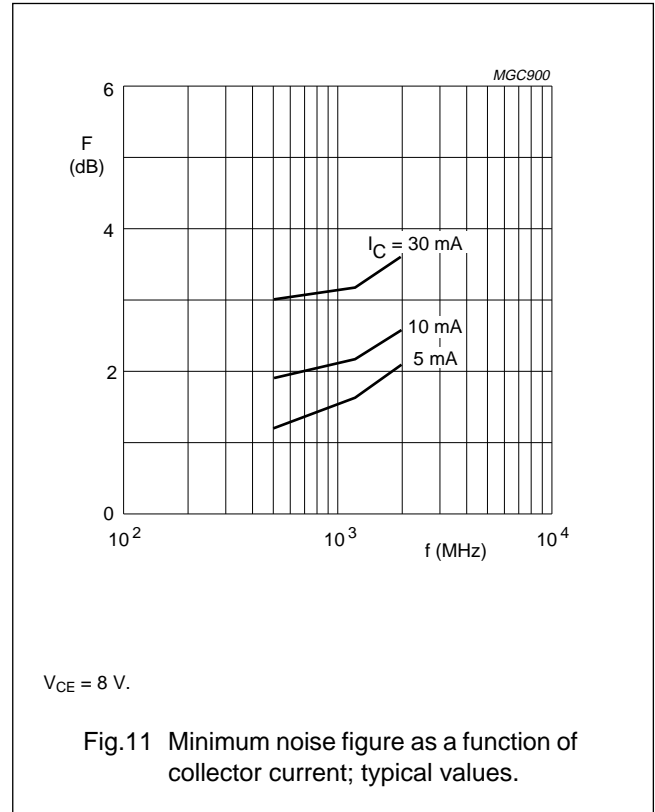
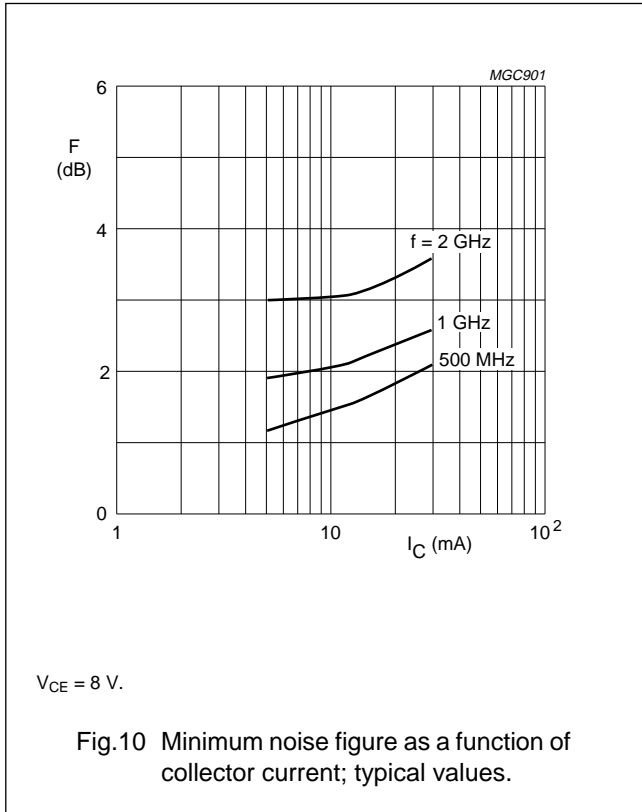

NPN 5 GHz wideband transistor

BFR93AW

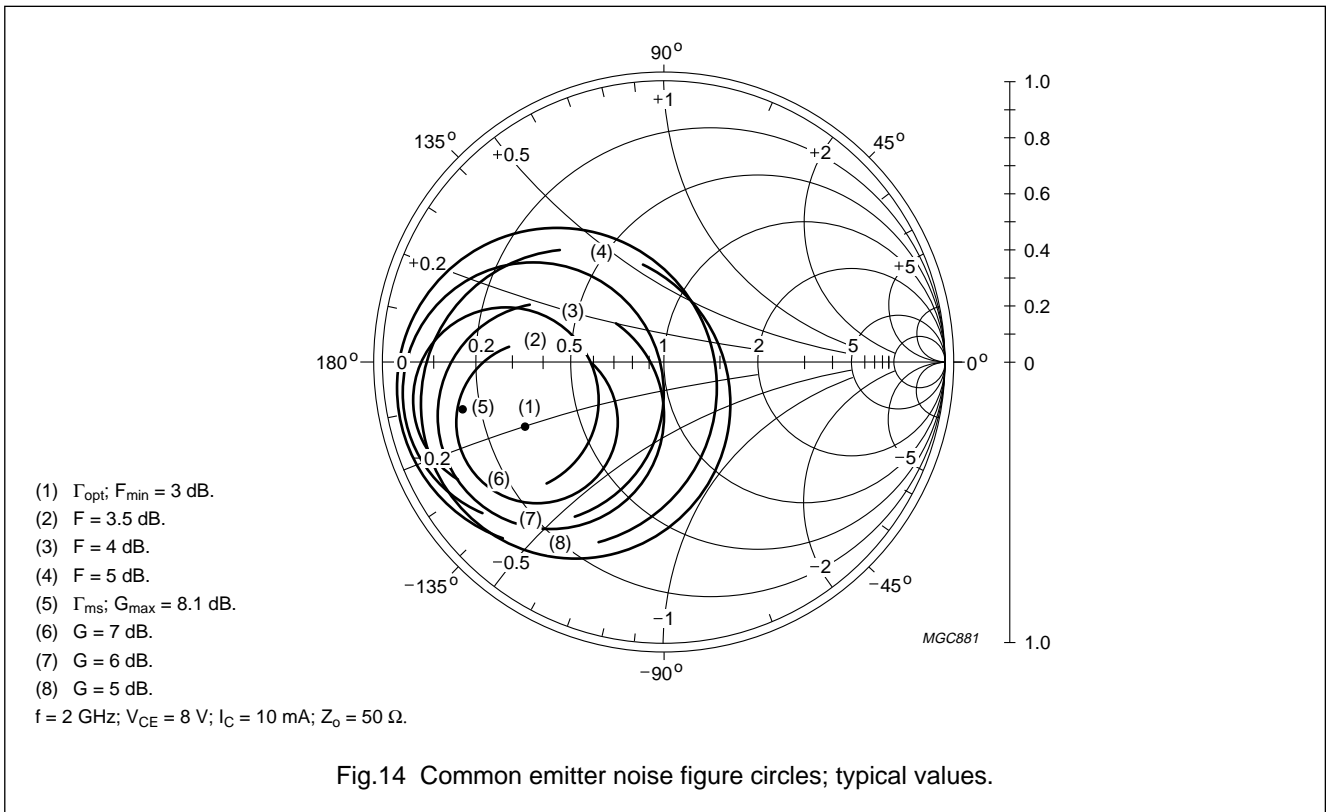
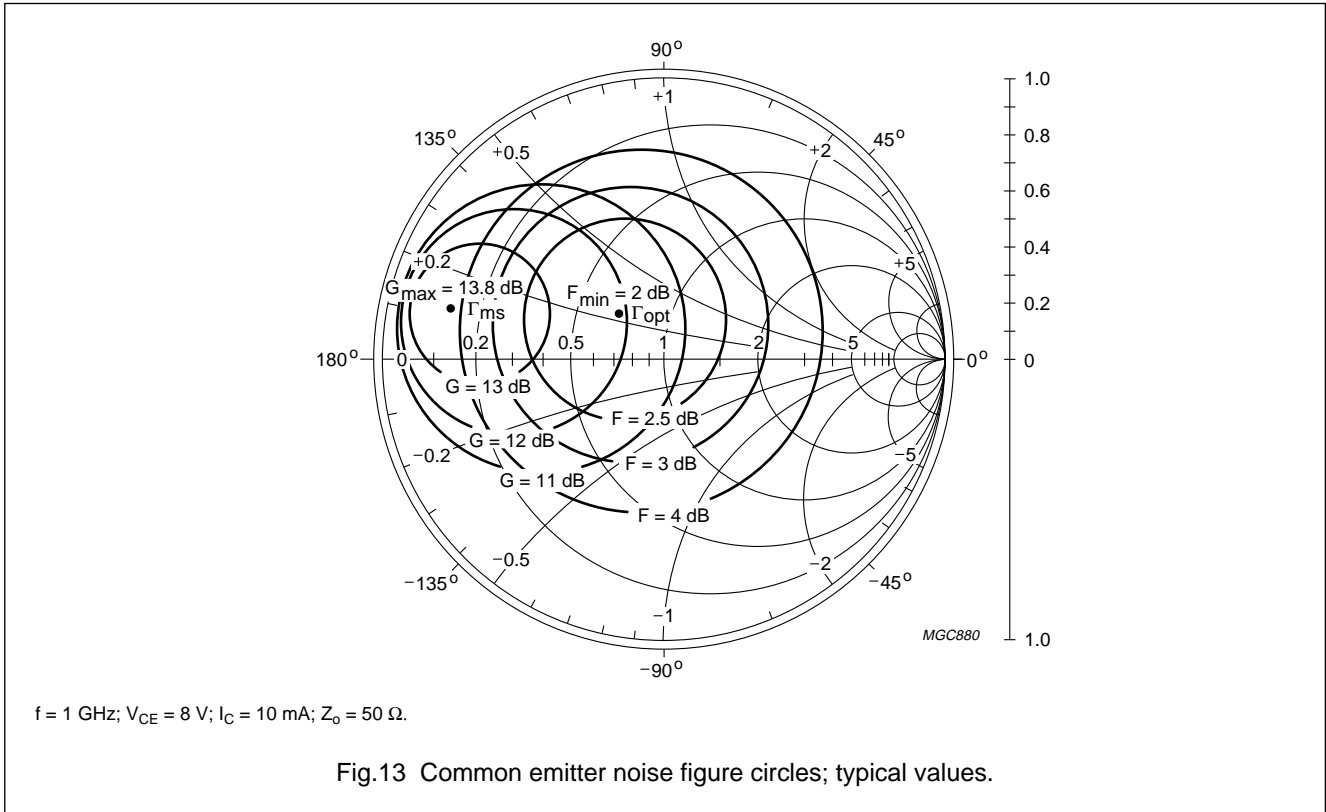

NPN 5 GHz wideband transistor

BFR93AW

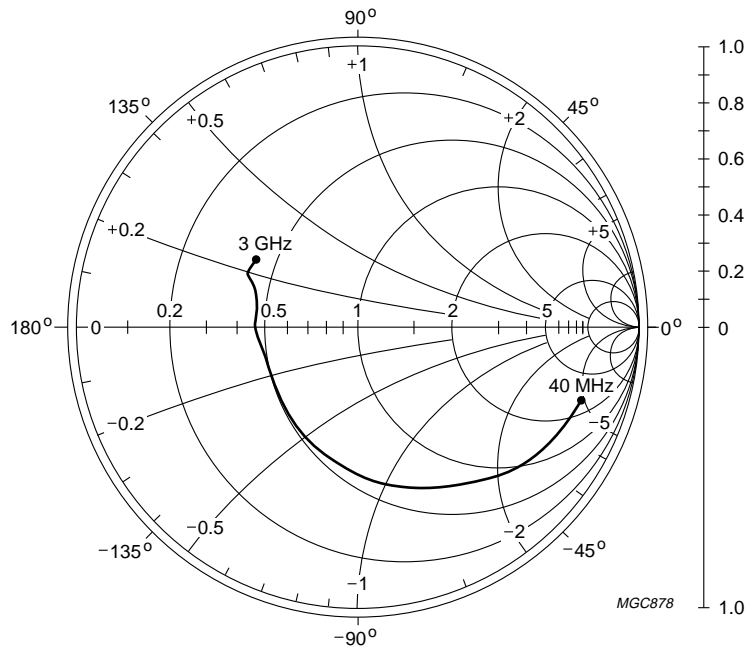

$V_{CE} = 8\text{ V}; I_C = 30\text{ mA}; Z_o = 50\ \Omega.$

Fig.15 Common emitter input reflection coefficient (s_{11}); typical values.

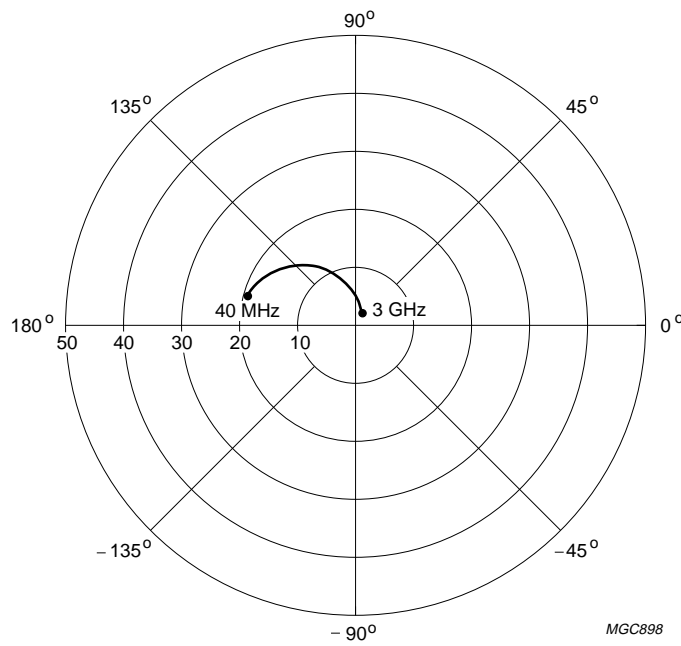

$V_{CE} = 8\text{ V}; I_C = 30\text{ mA}.$

Fig.16 Common emitter forward transmission coefficient (s_{21}); typical values.

NPN 5 GHz wideband transistor

BFR93AW

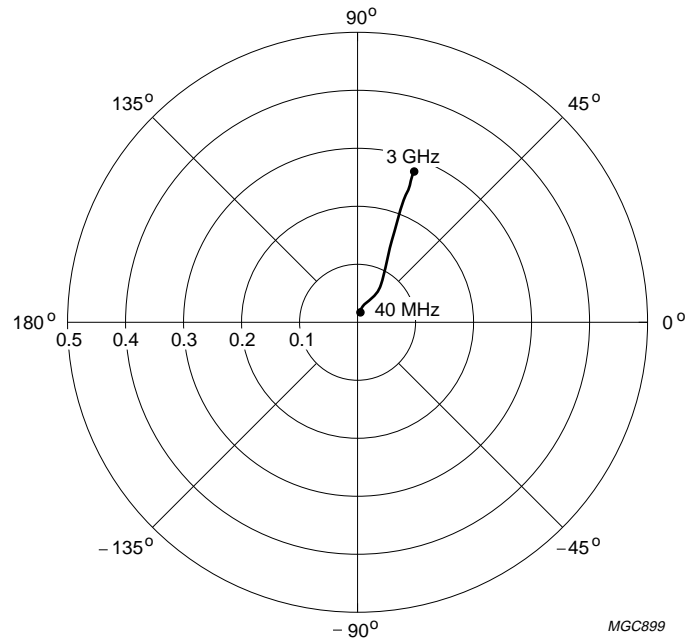

$V_{CE} = 8\text{ V}; I_C = 30\text{ mA}$.

Fig.17 Common emitter reverse transmission coefficient (s_{12}); typical values.

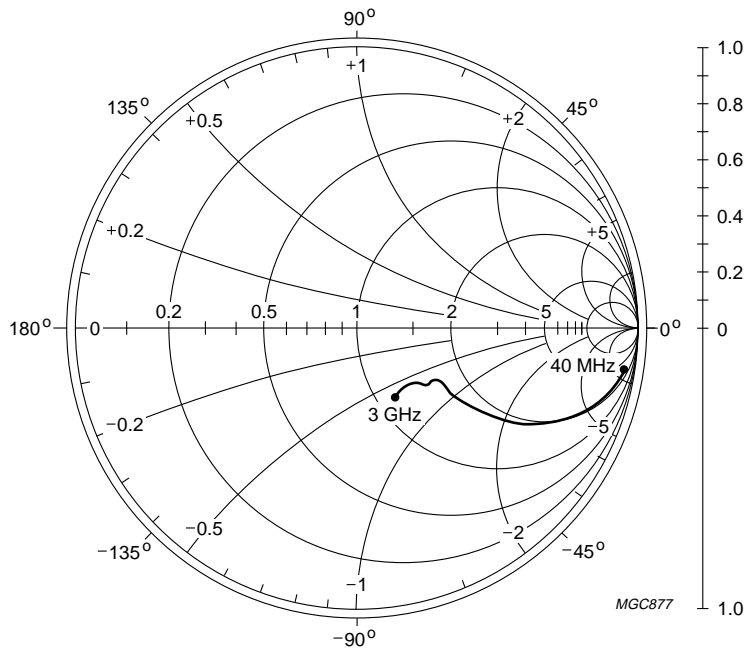

$V_{CE} = 8\text{ V}; I_C = 30\text{ mA}; Z_o = 50\ \Omega$.

Fig.18 Common emitter output reflection coefficient (s_{22}); typical values.

NPN 5 GHz wideband transistor

BFR93AW

PACKAGE OUTLINE

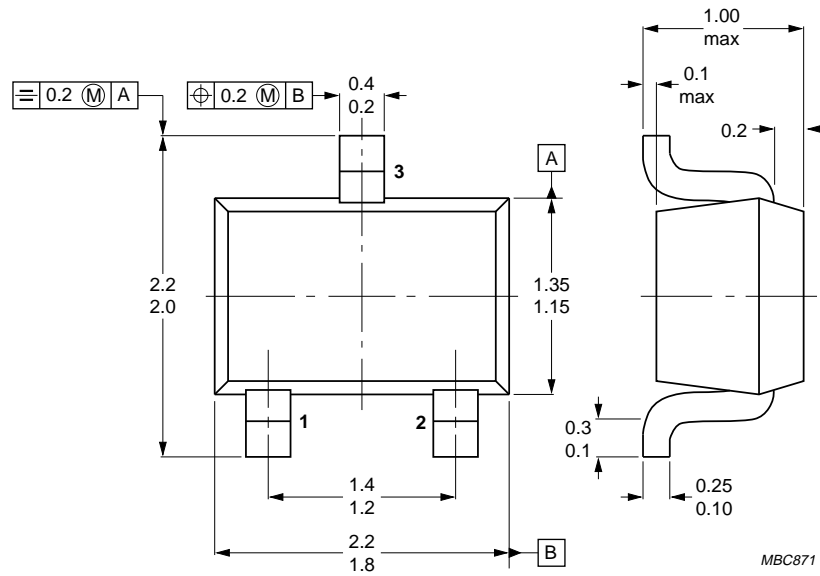

Dimensions in mm.

Fig.19 SOT323.

NPN 5 GHz wideband transistor

BFR93AW

DEFINITIONS

Data sheet status	
Objective specification	This data sheet contains target or goal specifications for product development.
Preliminary specification	This data sheet contains preliminary data; supplementary data may be published later.
Product specification	This data sheet contains final product specifications.
Limiting values	
Limiting values given are in accordance with the Absolute Maximum Rating System (IEC 134). Stress above one or more of the limiting values may cause permanent damage to the device. These are stress ratings only and operation of the device at these or at any other conditions above those given in the Characteristics sections of the specification is not implied. Exposure to limiting values for extended periods may affect device reliability.	
Application information	
Where application information is given, it is advisory and does not form part of the specification.	

LIFE SUPPORT APPLICATIONS

These products are not designed for use in life support appliances, devices, or systems where malfunction of these products can reasonably be expected to result in personal injury. Philips customers using or selling these products for use in such applications do so at their own risk and agree to fully indemnify Philips for any damages resulting from such improper use or sale.